

meTime_spa



Art.-Nr.: 03507/340401 katalog meTime_spa, englisch, 06/14



KEUCO



Tesseraux + Partner – Dominik Tesseraux

“There’s no point doing something again if you don’t improve it in the process. While developing meTime_spa our main focus was on uniting comfort, functionality and design in a new way to make a harmonious whole. The glass panel comes in such a variety of colours that anyone can create their own personal furnishing style.”

meTime_spa was designed by the studio Tesseraux + Partner



SHOWER EXPERIENCE FOR THE SENSES



The bathroom is increasingly becoming a place of relaxation and regeneration. The sensual experience of water increasingly has priority. Wellness in the bathroom starts with a homely atmosphere and is crowned by meTime_spa products from KEUCO.

In an elegant yet innovative way the completely new kind of concealed thermostat meTime_spa combines everything one needs for a relaxing shower or bath experience. The convenient water control system and the extraordinary design of the glass panel establish an entirely personal atmosphere in the room.

meTime_spa

DESIGN AND COMFORT HARMONIOUSLY COMBINED



Available in different sizes, meTime_spa integrates the control elements and generous shelf space in a uniquely stylish way. In the upright model three aluminium shelves offer a generous amount of space for your favourite shower accessories. And for those who prefer it more slender and compact, the perfect solution can be found in the small landscape model. Ideally suited as bathtub thermostat, it comes with the control elements on the right or the left.

Marvellously flexible: With meTime_spa, depending on the model, one, two or even three users can be controlled. Whether head or hand shower, bath spout or spa hose, the perfectly chrome-plated handles are both a visual as well as sensual treat, fresh and new every day. Even without mixing in hot water, the thermostat is especially ideal for healthy showers of alternating temperatures.





INTRODUCE COLOUR IN THE BATHROOM



The panel made of glass is available in seven different colours, for optimal integration in your own personal furnishing style. Only precisely ground, high-quality safety glass is used, which – combined with the premium aluminium shelves – won't just impress you by its high-quality appearance.

Moreover, the glass's special coating causes the water to simply bead off, and it is also hygienic and easy to clean.

AVAILABLE GLASS COLOURS

- Cashmere satin
- White satin
- Cashmere clear
- White clear
- Anthracite clear
- Truffle clear
- Petrol (RAL 5020) clear





INNOVATIVE TECHNOLOGY IN AN ELEGANT SETTING

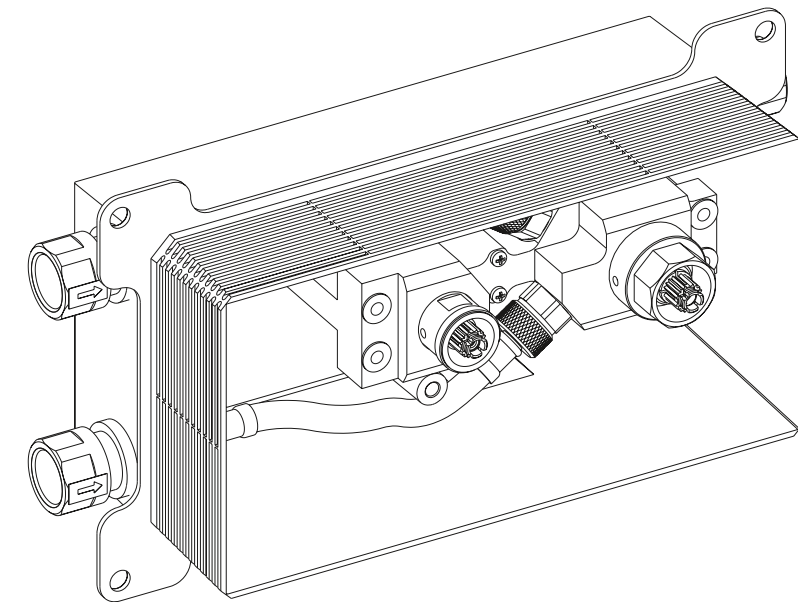

The essentials are invisible to the eye: In the wall, too, the fitting offers the installer new technical features. The basis is KEUCO's innovative concealed box. The special custom-developed installation unit makes installation of the meTime_spa fitting convenient, reliable and precise. Thanks to the flexible pipes and the movable installation unit, tolerances which can come into play during installation can be perfectly compensated for during the fine installation work for the glass plate.



More information in the form of a descriptive animated film is available at the QR code shown here.

PRODUCT OVERVIEW



Glass colour variations

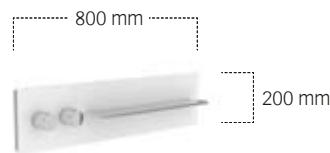
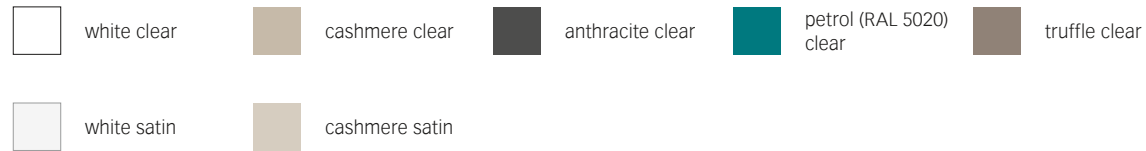

56161

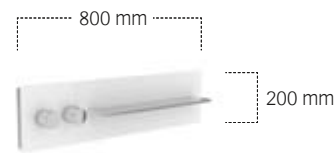

56162

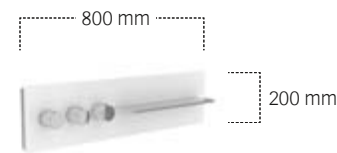

56163



53086/53089

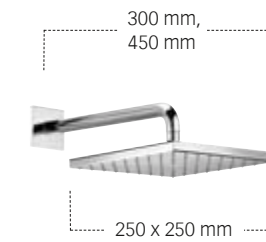

53086/53088

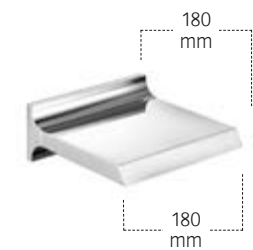

59982

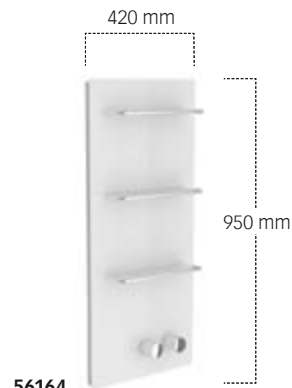

56164

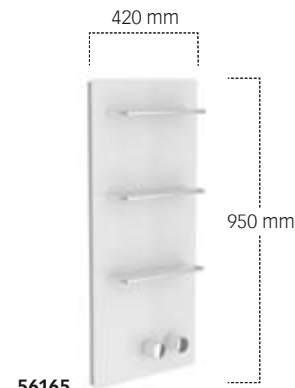

56165

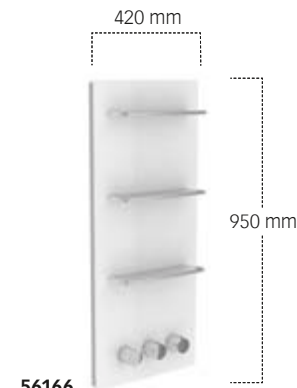

56166



56080



51192



59993



59996

56161
Shower and bathtub board with thermostat battery DN 20
 Finish set for the regulation of 1 user handles as desired left or right complete with:
 – Mounting frame
 – Panel made of ESG glass, with frame and one shelf made of aluminium
 – Knob for thermostat with safety cut-off at 38°C
 – Shut-off handle
 Dimensions (w x h): 800 x 200 mm
 (essential for installation: rough part article no. 56161 000071 to be ordered separately)

56164
Shower board with thermostat battery DN 20
 Finish set for the regulation of 1 user handles right complete with:
 – Mounting frame
 – Panel made of ESG glass, with frame and three shelves made of aluminium
 – Knob for thermostat with safety cut-off at 38°C
 – Shut-off handle
 Dimensions (w x h): 420 x 950 mm
 (essential for installation: rough part article no. 56161 000071 to be ordered separately)

56162
Shower and bathtub board with thermostat battery DN 20
 Finish set for the regulation of 2 users handles as desired left or right complete with:
 – Mounting frame
 – Panel made of ESG glass, with frame and one shelf made of aluminium
 – Knob for thermostat with safety cut-off at 38°C
 – Shut-off and adjustment handle
 Dimensions (w x h): 800 x 200 mm
 (essential for installation: rough part article no. 56162 000072 to be ordered separately)

56165
Shower board with thermostat battery DN 20
 Finish set for the regulation of 2 users handles right complete with:
 – Mounting frame
 – Panel made of ESG glass, with frame and three shelves made of aluminium
 – Knob for thermostat with safety cut-off at 38°C
 – Shut-off and adjustment handle
 Dimensions (w x h): 420 x 950 mm
 (essential for installation: rough part article no. 56162 000072 to be ordered separately)

56163
Shower and bathtub board with thermostat battery DN 20
 Finish set for the regulation of 3 users handles as desired left or right complete with:
 – Mounting frame
 – Panel made of ESG glass, with frame and one shelf made of aluminium
 – Knob for thermostat with safety cut-off at 38°C
 – Shut-off handle
 – Adjustment grip
 Dimensions (w x h): 800 x 200 mm
 (essential for installation: rough part article no. 56163 000073 to be ordered separately)

56166
Shower board with thermostat battery DN 20
 Finish set for the regulation of 3 users handles right complete with:
 – Mounting frame
 – Panel made of ESG glass, with frame and three shelves made of aluminium
 – Knob for thermostat with safety cut-off at 38°C
 – Shut-off handle
 – Adjustment grip
 Dimensions (w x h): 420 x 950 mm
 (essential for installation: rough part article no. 56163 000073 to be ordered separately)

53086/53089
Shower head with ceiling outlet DN 15
 with shower head rail restricted flow rate 15 l/min. Projection: 100, 300 mm

56080
Round pencil hand shower
 with normal jet

51192
Wall outlet for hand shower DN 15
 with integrated wall outlet for shower hoses with conical nuts suitable for all concealed fittings with backflow preventer

53086/53088
Shower head with wall outlet DN 15
 with shower head rail restricted flow rate 15 l/min. Projection: 300, 450 mm

59993
Wall outlet for shower hose DN 20
 with wall bracket, for SPA hose, suitable for all concealed fittings with backflow preventer

59996
SPA hose
 with chrome-plated shower bracket for wall connection elbow and chrome-plated hose connection 3/4"

59982
Waterfall shower
 for wall connection G 1/2 Inch restricted flow rate 25 l/min. Projection: 180 mm

SOURCE OF INSPIRATION

meTime_spa



Verzasca valley, Switzerland, starting point of a fascinating journey: The New York photographer Stephan Schacher sets the stage for meTime_spa in unusual locations around the world. Nature and design merge together in the photographs in a sensual play of material, form and colour.



Stephan Schacher, Photographer

In accordance with our manufacturer's guarantee declaration, we assume a guarantee of five years for our products, provided that the product was verifiably purchased and installed by a franchised trade dealer.

The guarantee period commences with the date of delivery ex works. The statutory warranty period is included in the guarantee period. This guarantee excludes electrical components and light bulbs.

The extraordinary surface characteristics and extremely fine colour nuances of our products can only be reproduced to a certain degree in print. Only the original KEUCO products, which can be viewed in sanitary trade dealers' showrooms, can provide you with an optimum impression.

Reproduction and copying, even if only excerpts, are only permitted by explicit permission of the manufacturer, and with the inclusion of source information.
KEUCO GmbH & Co. KG, Postfach 1365, D-58653 Hemer

We reserve the right to make engineering changes for the purpose of improvement, as well as colour and design changes that are deemed necessary. Errors and omissions excepted.

Our articles are sold exclusively through sanitary wholesale.

Concept, design and lithography: Kontrast Communication Services GmbH, Düsseldorf
Text: KEUCO, Kontrast Communication Services GmbH, Düsseldorf
Photography: Stephan Schacher, New York; Casa, Münster; provideo & fototeam, Menden
Printing: Meinders & Elstermann GmbH & Co. KG, Belm, Osnabrück
Printed on GALAXI Keramik. Supplied by Papier Union.

For more information please visit www.keuco.de

